

Part Number: KM2520VBC-D01

Blue



ATTENTION
OBSERVE PRECAUTIONS
FOR HANDLING
ELECTROSTATIC
DISCHARGE
SENSITIVE
DEVICES

Features

- Subminiature package.
- Long life solid state reliability.
- Low package profile.
- Moisture sensitivity level : level 3.
- RoHS compliant.

Description

The Blue source color devices are made with InGaN Light Emitting Diode.

Static electricity and surge damage the LEDs.

It is recommended to use a wrist band or anti-electrostatic glove when handling the LEDs.

All devices, equipment and machinery must be electrically grounded.

Package Dimensions

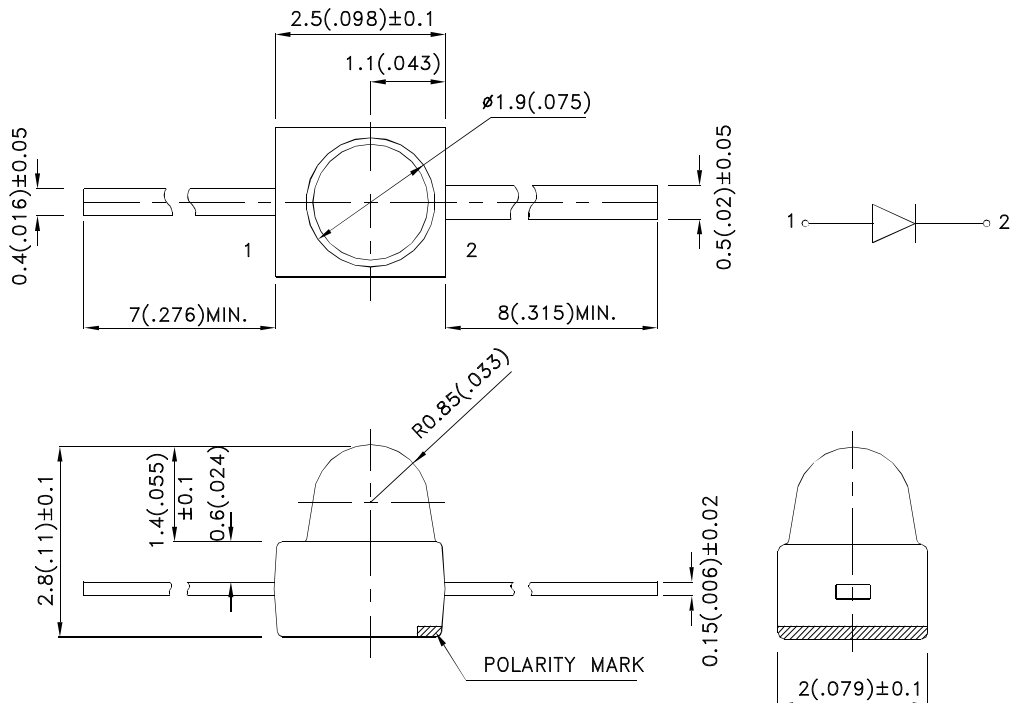

Notes:

1. All dimensions are in millimeters (inches).
2. Tolerance is $\pm 0.25(0.01)$ " unless otherwise noted.
3. Lead spacing is measured where the leads emerge from the package.
4. The specifications, characteristics and technical data described in the datasheet are subject to change without prior notice.



Selection Guide

Part No.	Dice	Lens Type	Iv (mcd) [2] @ 20mA		Viewing Angle [1]
			Min.	Typ.	2θ1/2
KM2520VBC-D01	Blue (InGaN)	Water Clear	1000	1600	20°

Notes:

1. θ1/2 is the angle from optical centerline where the luminous intensity is 1/2 of the optical peak value.
2. Luminous intensity/ luminous Flux: +/-15%.
3. Luminous intensity value is traceable to the CIE127-2007 compliant national standards.

Electrical / Optical Characteristics at TA=25°C

Symbol	Parameter	Device	Typ.	Max.	Units	Test Conditions
λ _{peak}	Peak Wavelength	Blue	465		nm	I _F =20mA
λ _D [1]	Dominant Wavelength	Blue	470		nm	I _F =20mA
Δλ _{1/2}	Spectral Line Half-width	Blue	22		nm	I _F =20mA
C	Capacitance	Blue	100		pF	V _F =0V;f=1MHz
V _F [2]	Forward Voltage	Blue	3.3	4	V	I _F =20mA
I _R	Reverse Current	Blue		50	uA	V _R = 5V

Notes:

1. Wavelength: +/-1nm.
2. Forward Voltage: +/-0.1V.
3. Wavelength value is traceable to the CIE127-2007 compliant national standards.

Absolute Maximum Ratings at TA=25°C

Parameter	Blue	Units
Power dissipation	120	mW
DC Forward Current	30	mA
Peak Forward Current [1]	100	mA
Reverse Voltage	5	V
Operating/Storage Temperature	-40°C To +85°C	
Lead Solder Temperature [2]	260°C For 3 Seconds	
Lead Solder Temperature [3]	260°C For 5 Seconds	

Notes:

1. 1/10 Duty Cycle, 0.1ms Pulse Width.
2. 2mm below package base.
3. 5mm below package base.

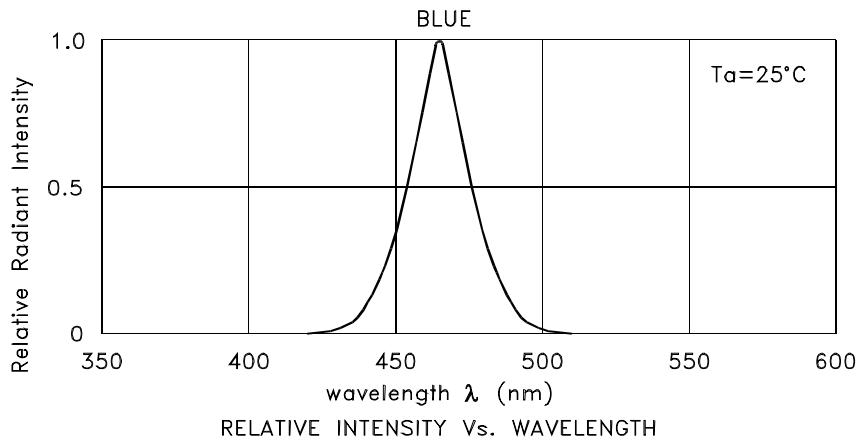

Blue

KM2520VBC-D01

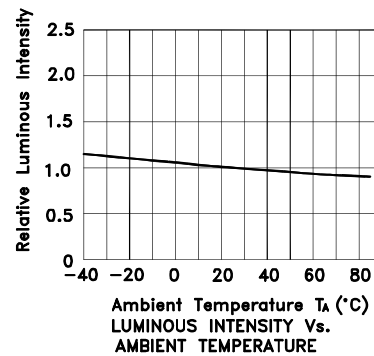
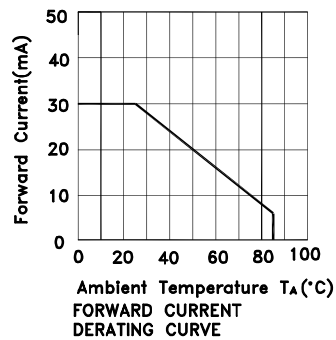
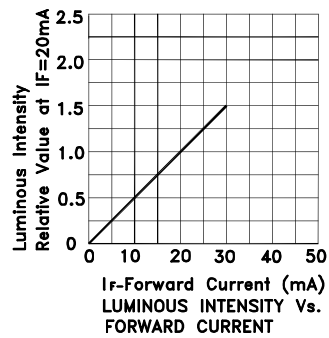
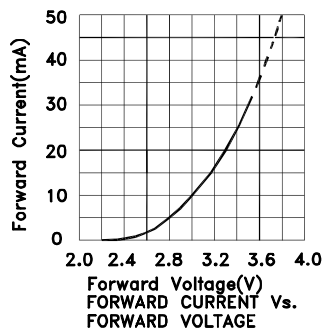

Kingbright

PACKING & LABEL SPECIFICATIONS

KM2520VBC-D01

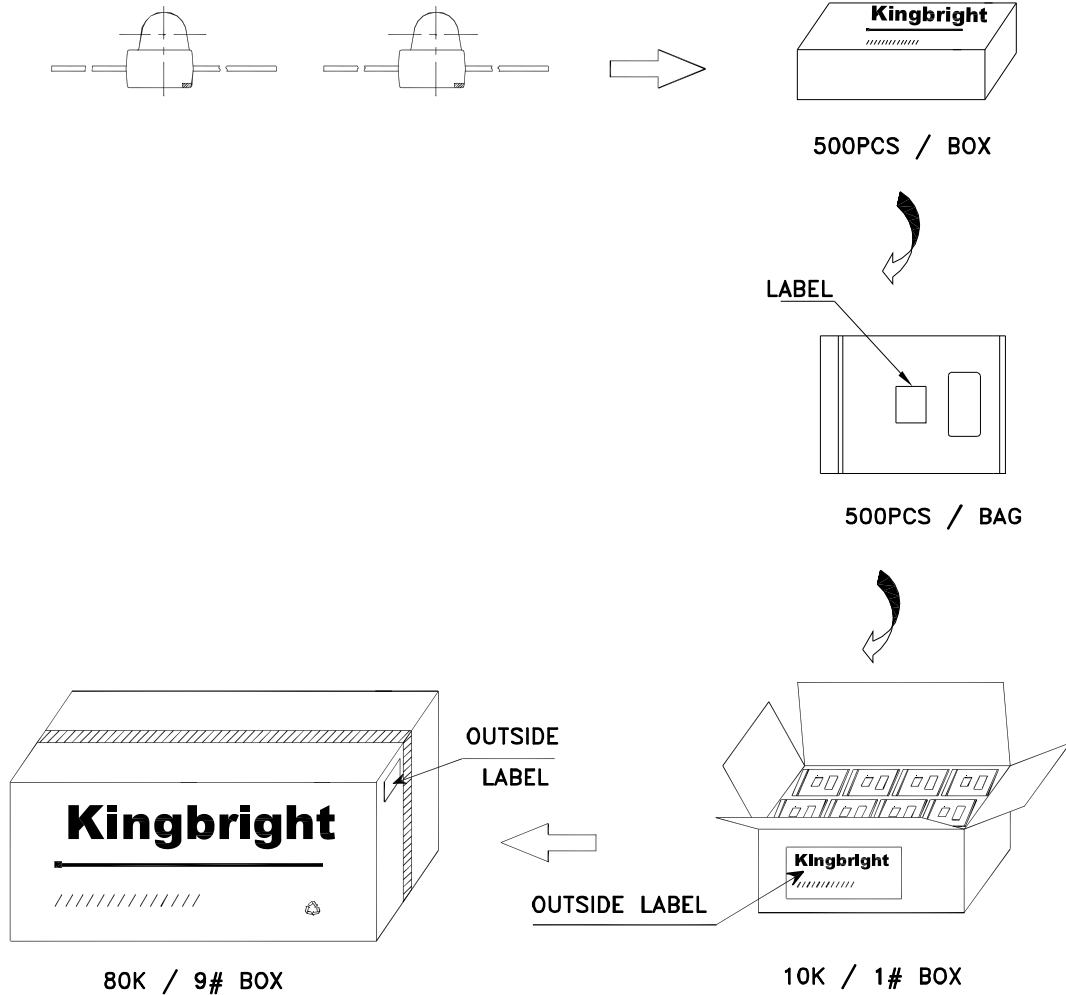

<h1>Kingbright</h1>				
P/N0: KM2520xxx01				
QTY: 500 pcs	Q.C.			
S/N: XXXX	<table border="1" style="margin: auto;"> <tr> <td style="text-align: center;">Q C</td> </tr> <tr> <td style="text-align: center;">XX XX XXXX</td> </tr> <tr> <td style="text-align: center;">PASSED</td> </tr> </table>	Q C	XX XX XXXX	PASSED
Q C				
XX XX XXXX				
PASSED				
CODE: XXX				
LOT NO:				
XXXXXXXXXXXXXXXXXX				
RoHS Compliant				

Detailed application notes are listed on our website.
http://www.kingbright.com/application_notes