

Part Number: KPTB-1615SURKCGKC

Hyper Red
Green

Features

- 1.6mmx1.5mm SMT LED, 0.7mm thickness.
- Low power consumption.
- Wide viewing angle.
- Ideal for backlight and indicator.
- Various colors and lens types available.
- Package : 2000pcs / reel.
- Moisture sensitivity level : level 3.
- RoHS compliant.

Description

The Hyper Red source color devices are made with AlGaInP on GaAs substrate Light Emitting Diode.

The Green source color devices are made with AlGaInP on GaAs substrate Light Emitting Diode.

Package Dimensions

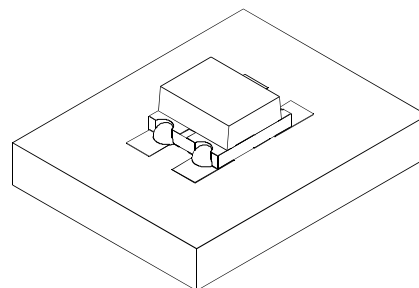
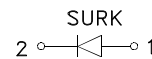
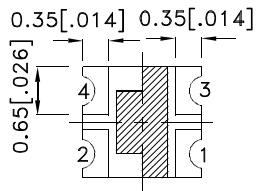
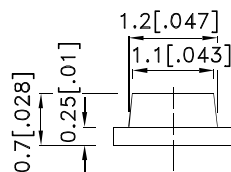
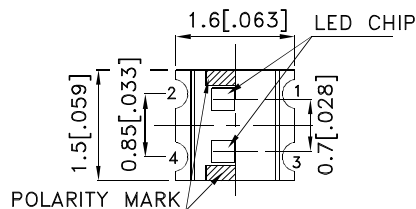

Notes:

1. All dimensions are in millimeters (inches).
2. Tolerance is $\pm 0.2(0.008)$ unless otherwise noted.
3. The specifications, characteristics and technical data described in the datasheet are subject to change without prior notice.
4. The device has a single mounting surface. The device must be mounted according to the specifications.



Selection Guide

Part No.	Dice	Lens Type	Iv (mcd) [2] @ 20mA		Viewing Angle [1]
			Min.	Typ.	2θ1/2
KPTB-1615SURKCGKC	Hyper Red (AlGaInP)	Water Clear	120	200	120°
			*40	*80	
	Green (AlGaInP)		20	50	
			*20	*50	

Notes:

1. $\theta_{1/2}$ is the angle from optical centerline where the luminous intensity is 1/2 of the optical peak value.

2. Luminous intensity/ Luminous Flux: +/-15%.

* Luminous intensity value is traceable to the CIE127-2007 compliant national standards.

Electrical / Optical Characteristics at TA=25°C

Symbol	Parameter	Device	Typ.	Max.	Units	Test Conditions
λ_{peak}	Peak Wavelength	Hyper Red Green	645 574		nm	I _F =20mA
λ_D [1]	Dominant Wavelength	Hyper Red Green	630 570		nm	I _F =20mA
$\Delta\lambda_{1/2}$	Spectral Line Half-width	Hyper Red Green	28 20		nm	I _F =20mA
C	Capacitance	Hyper Red Green	35 15		pF	V _F =0V;f=1MHz
V _F [2]	Forward Voltage	Hyper Red Green	1.95 2.1	2.5 2.5	V	I _F =20mA
I _R	Reverse Current	Hyper Red Green		10 10	uA	V _R = 5V

Notes:

1. Wavelength: +/-1nm.

2. Forward Voltage: +/-0.1V.

3. Wavelength value is traceable to the CIE127-2007 compliant national standards.

Absolute Maximum Ratings at TA=25°C

Parameter	Hyper Red	Green	Units
Power dissipation	75	75	mW
DC Forward Current	30	30	mA
Peak Forward Current [1]	185	150	mA
Reverse Voltage	5		V
Operating Temperature	-40°C To +85°C		
Storage Temperature	-40°C To +85°C		

Note:

1. 1/10 Duty Cycle, 0.1ms Pulse Width.

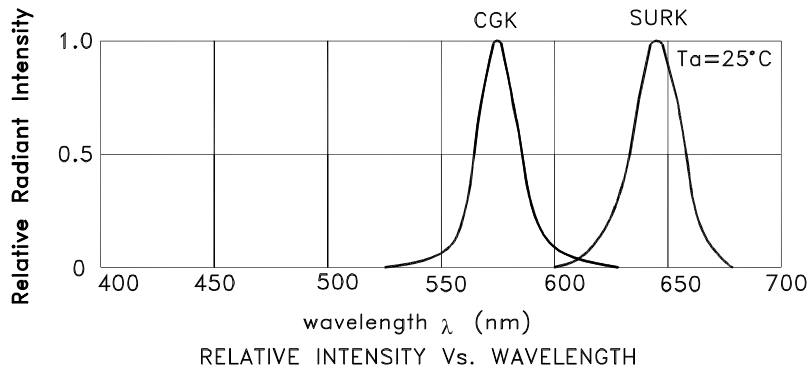

KPTB-1615SURKCGKC Hyper Red

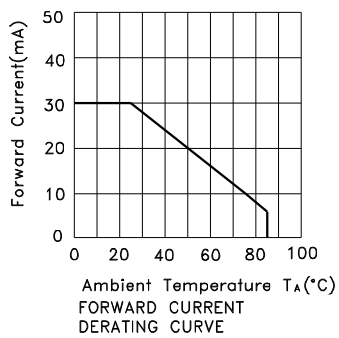
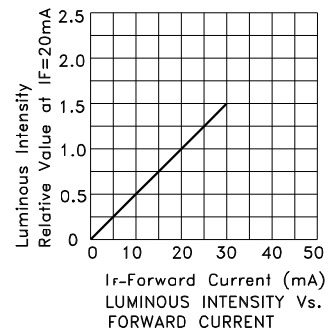
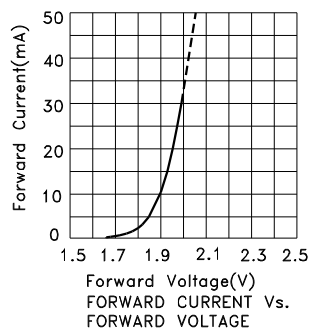

Green

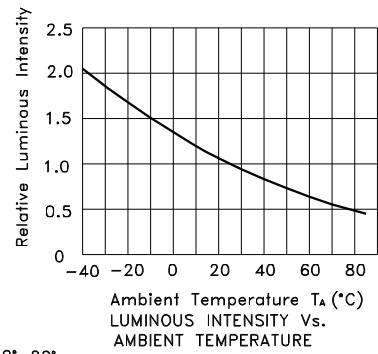
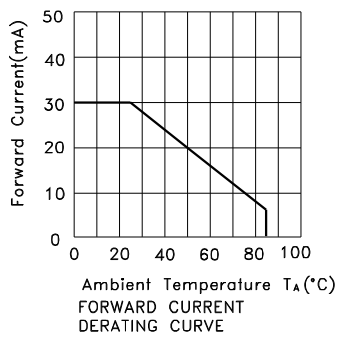
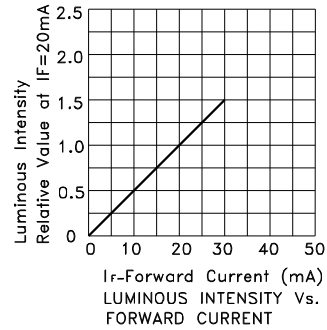

KPTB-1615SURKCGKC

Reflow soldering is recommended and the soldering profile is shown below.
Other soldering methods are not recommended as they might cause damage to the product.

Reflow Soldering Profile For Lead-free SMT Process.



NOTES:

1. We recommend the reflow temperature 245°C(+/-5°C). The maximum soldering temperature should be limited to 260°C.
2. Don't cause stress to the epoxy resin while it is exposed to high temperature.
3. Number of reflow process shall be 2 times or less.

Recommended Soldering Pattern (Units : mm; Tolerance: ± 0.1)

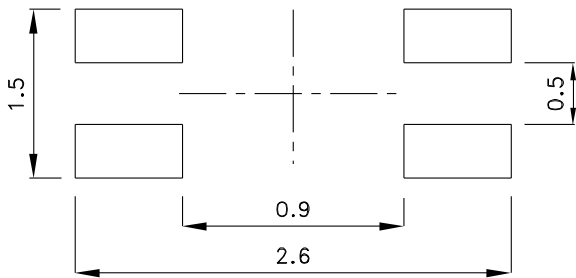

Reel Dimension



Tape Dimensions (Units : mm)

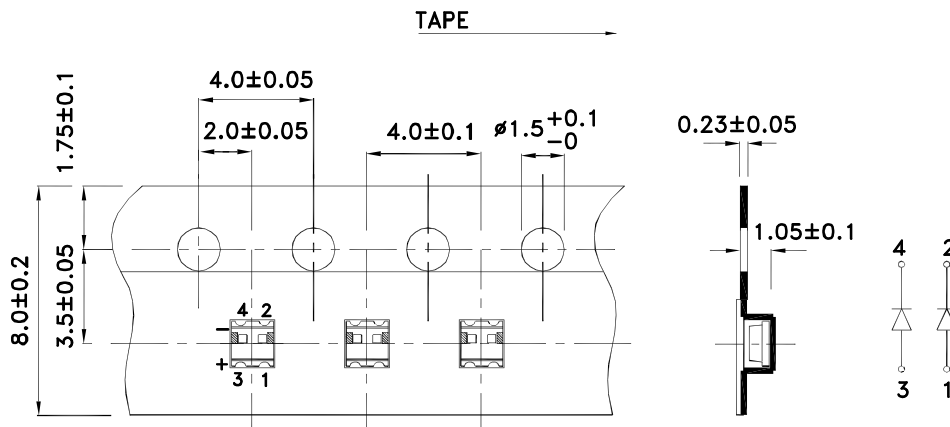

Kingbright

PACKING & LABEL SPECIFICATIONS

KPTB-1615SURKCGKC

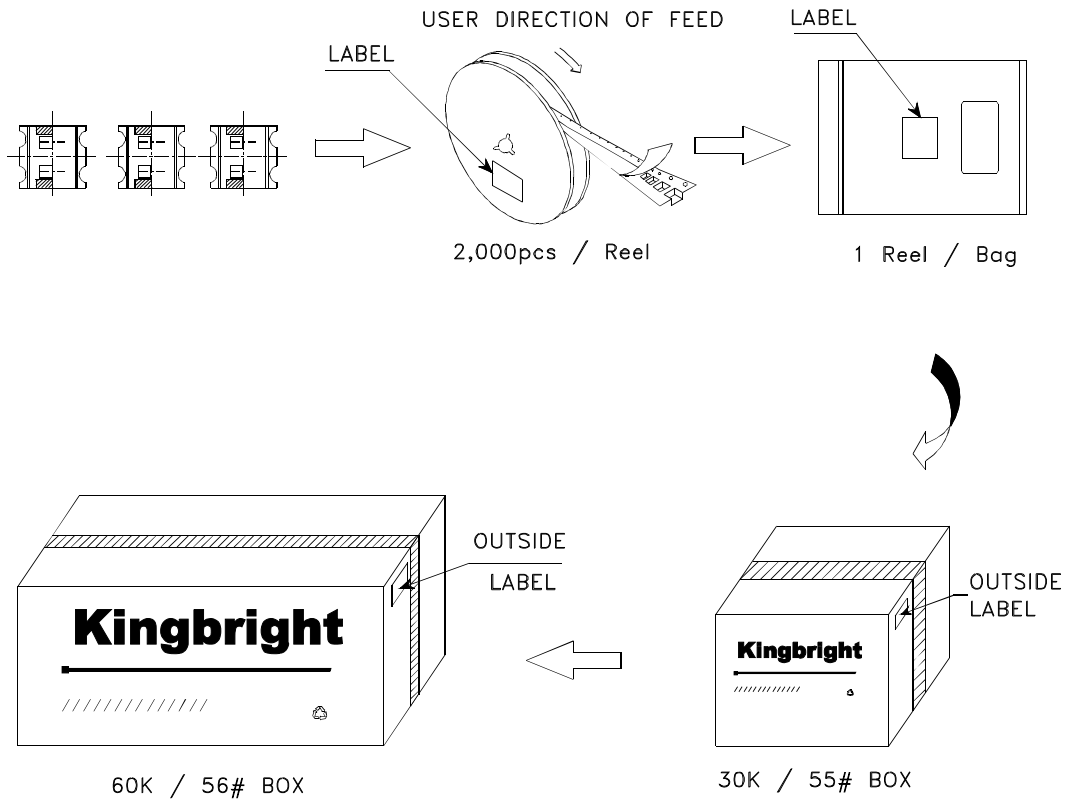

Kingbright	
P/NO: KPTB-1615xxx	
QTY: 2,000 pcs	Q.C. Q C XX XX XXXX PASSED
S/N: XXXX	
CODE: XXX	
LOT NO:	
 xxxxxxxxxxxxxxxxxxxxxxxxx	
RoHS Compliant	

Detailed application notes are listed on our website.
http://www.kingbright.com/application_notes