

Part Number: CA25-12SYKWA

Super Bright Yellow

### Features

- 0.25 inch digit height
- Low current operation.
- Excellent character appearance.
- Easy mounting on P.C. boards or sockets.
- Categorized for luminous intensity.
- Mechanically rugged.
- Standard : gray face, white segment.
- RoHS compliant.

### Description

The Super Bright Yellow device is made with AlGaInP (on GaAs substrate) light emitting diode chip.

### Package Dimensions & Internal Circuit Diagram

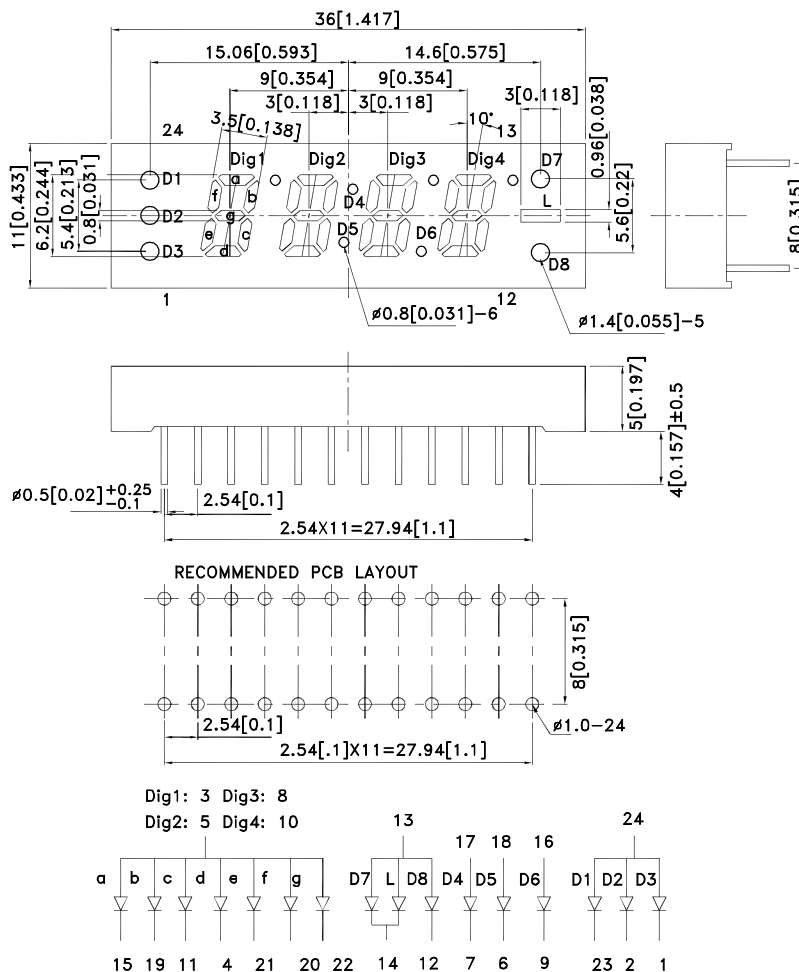

**Notes:**

1. All dimensions are in millimeters (inches), Tolerance is  $\pm 0.25(0.01)$  unless otherwise noted.
2. The specifications, characteristics and technical data described in the datasheet are subject to change without prior notice.



## Selection Guide

Part No.	Dice	Lens Type	Iv (ucd) [1] @ 10mA		Description
			Min.	Typ.	
CA25-12SYKWA	Super Bright Yellow (AlGaInP)	White Diffused	52000	110000	Common Anode
			*14000	*35000	

Notes:

1. Luminous intensity/ luminous Flux: +/-15%.

\*Luminous intensity value is traceable to the CIE127-2007 compliant national standards.

## Electrical / Optical Characteristics at TA=25°C

Symbol	Parameter		Device	Typ.	Max.	Units	Test Conditions
$\lambda$ peak	Peak Wavelength		Super Bright Yellow	590		nm	IF=20mA
$\lambda$ D [1]	Dominant Wavelength		Super Bright Yellow	590		nm	IF=20mA
$\Delta\lambda$ 1/2	Spectral Line Half-width		Super Bright Yellow	20		nm	IF=20mA
C	Capacitance		Super Bright Yellow	20		pF	VF=0V;f=1MHz
VF [2]	Forward Voltage	Dig1'8',Dig2'8',Dig3'8',Dig4'8' D1,D2,D3D4,D5,D6,D8	Super Bright Yellow	2.0	2.5	V	IF=20mA
		D7,L					
IR	Reverse Current	Dig1'8',Dig2'8',Dig3'8',Dig4'8' D1,D2,D3D4,D5,D6,D8	Super Bright Yellow		10	uA	VR = 5V
		D7,L			20		

Notes:

1. Wavelength: +/-1nm.

2. Forward Voltage: +/-0.1V.

3. Wavelength value is traceable to the CIE127-2007 compliant national standards.

## Absolute Maximum Ratings at TA=25°C

Parameter		Super Bright Yellow	Units
Power dissipation	Dig1'8',Dig2'8',Dig3'8',Dig4'8' D1,D2,D3D4,D5,D6,D8	75	mW
	D7,L	150	
DC Forward Current	Dig1'8',Dig2'8',Dig3'8',Dig4'8' D1,D2,D3D4,D5,D6,D8	30	mA
	D7,L	60	
Reverse Voltage	Dig1'8',Dig2'8',Dig3'8',Dig4'8' D1,D2,D3D4,D5,D6,D8	5	V
	D7,L		
Peak Forward Current [1]	Dig1'8',Dig2'8',Dig3'8',Dig4'8' D1,D2,D3D4,D5,D6,D8	175	mA
	D7,L	350	
Operating/Storage Temperature		-40°C To +85°C	
Lead Solder Temperature [2]		260°C For 3-5 Seconds	

Notes:

1. 1/10 Duty Cycle, 0.1ms Pulse Width.

2. 2mm below package base.

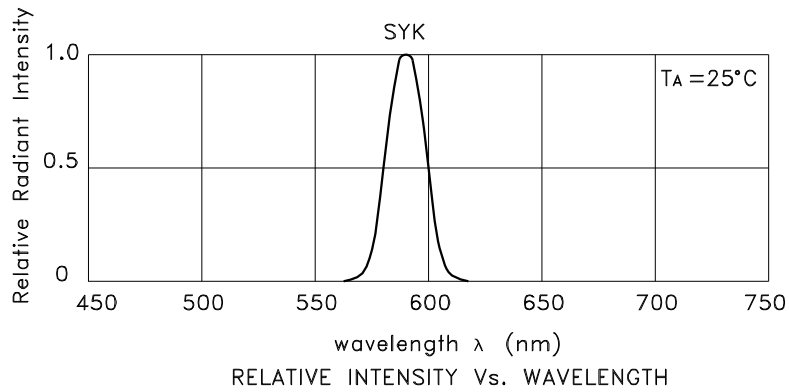

**Super Bright Yellow CA25-12SYKWA**

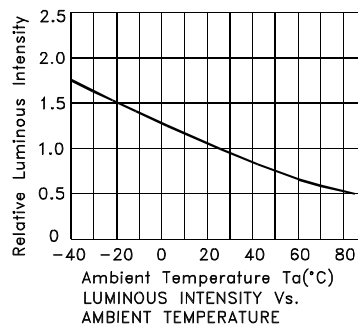
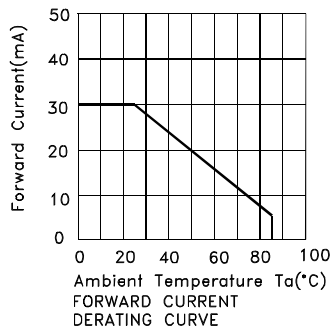
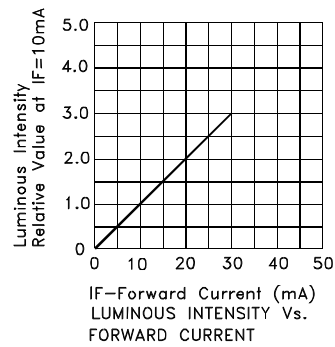
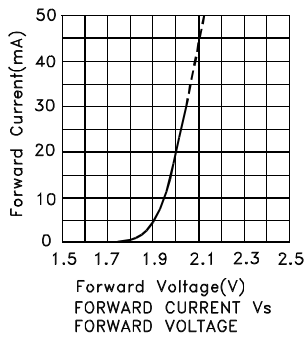

## Super Bright Yellow

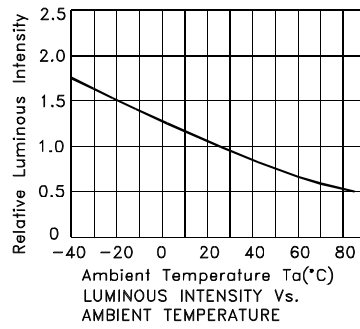
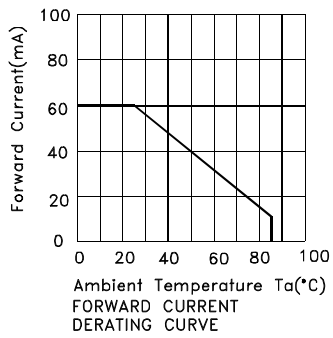
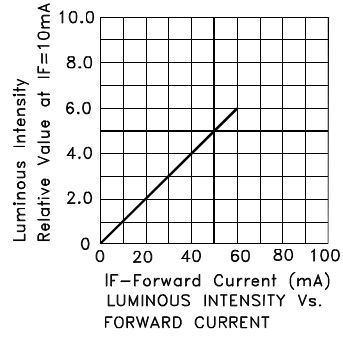
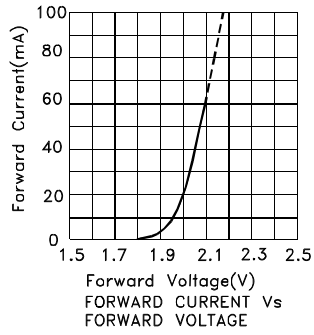

**PACKING & LABEL SPECIFICATIONS**

**CA25-12SYKWA**

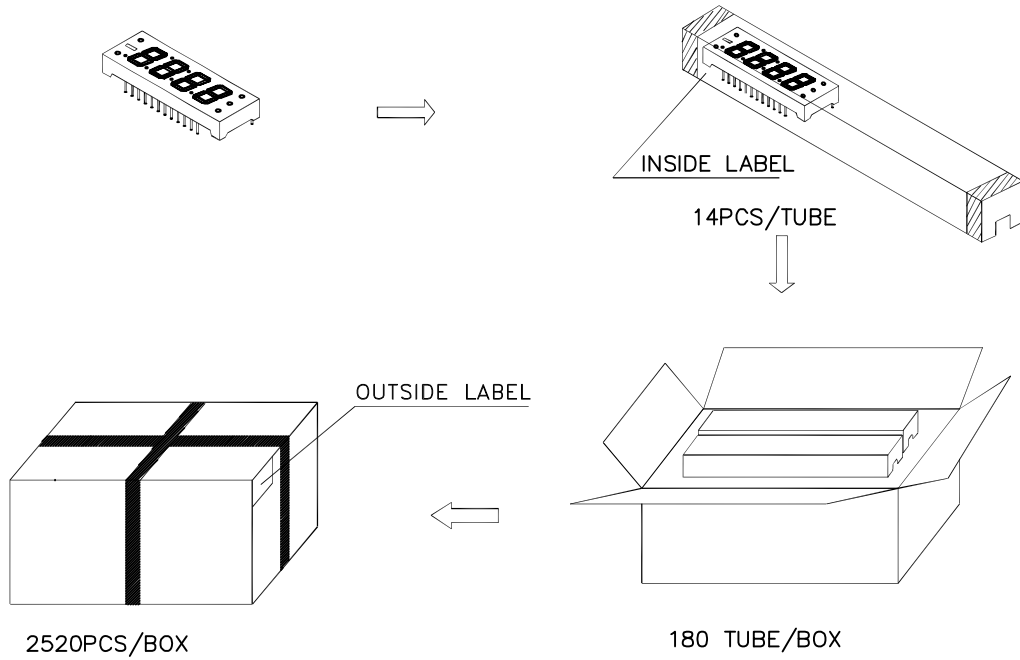

Inside Label on Ic-Tube

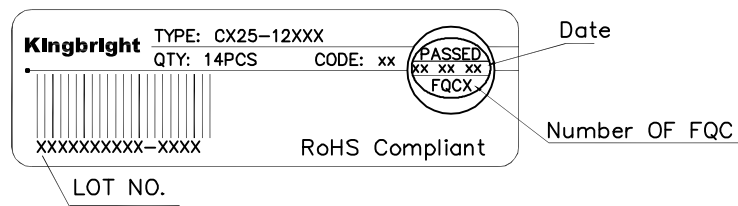

Outside Label on Box

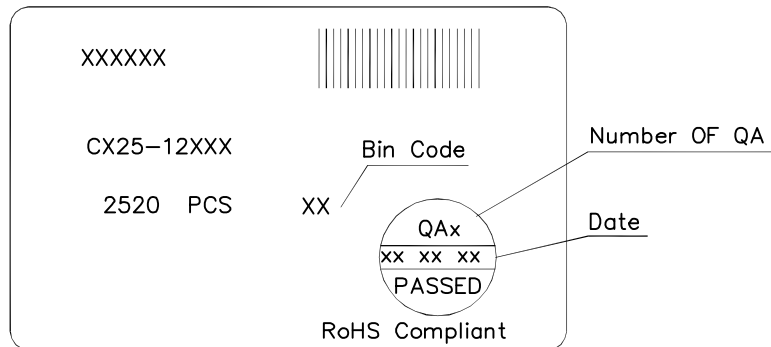

## THROUGH HOLE DISPLAY MOUNTING METHOD

### Lead Forming

Do not bend the component leads by hand without proper tools.  
The leads should be bent by clinching the upper part of the lead firmly such that the bending force is not exerted on the plastic body.

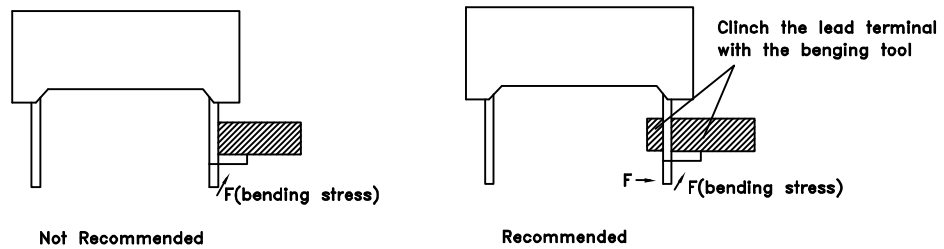

### Installation

- 1.The installation process should not apply stress to the lead terminals.
- 2.When inserting for assembly, ensure the terminal pitch matches the substrate board's hole pitch to prevent spreading or pinching the lead terminals.

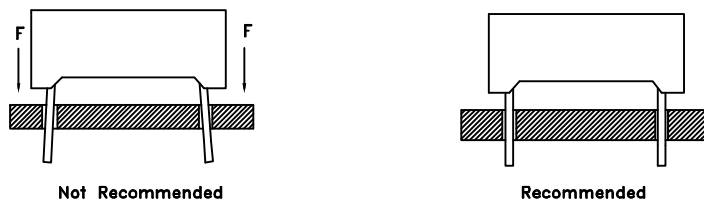

- 3.The component shall be placed at least 5mm from edge of PCB to avoid damage caused excessive heat during wave soldering.

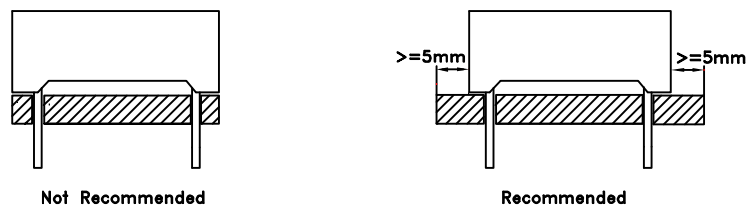

## DISPLAY SOLDERING CONDITIONS

Wave Soldering Profile For Lead-free Through-hole LED.

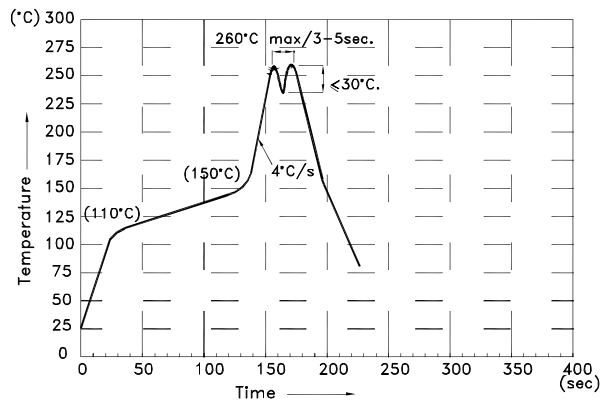

### NOTES:

1. Recommend the wave temperature 245°C~260°C. The maximum soldering temperature should be less than 260°C.
2. Do not apply stress on epoxy resins when temperature is over 85°C.
3. The soldering profile apply to the lead free soldering (Sn/Cu/Ag alloy).
4. During wave soldering, the PCB top-surface temperature should be kept below 105°C.
5. No more than once.

### Soldering General Notes:

1. Through-hole displays are incompatible with reflow soldering.
2. If components will undergo multiple soldering processes, or other processes where the components may be subjected to intense heat, please check with Kingbright for compatibility.

### CLEANING

1. Mild "no-clean" fluxes are recommended for use in soldering.
2. If cleaning is required, Kingbright recommends to wash components with water only. Do not use harsh organic solvents for cleaning, because they may damage the plastic parts. And the devices should not be washed for more than one minute.

### CIRCUIT DESIGN NOTES

1. Protective current-limiting resistors may be necessary to operate the Displays.
2. LEDs mounted in parallel should each be placed in series with its own current-limiting resistor.

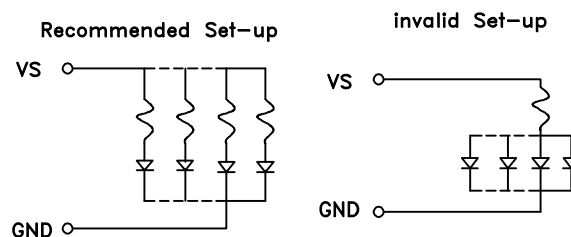

Detailed application notes are listed on our website.  
[http://www.kingbright.com/application\\_notes](http://www.kingbright.com/application_notes)