

Part Number: SA23-11SURKWA

Hyper Red

### Features

- 2.3 inch digit height.
- Low current operation.
- Excellent character appearance.
- High light output.
- Easy mounting on P.C. boards or sockets.
- Multicolor available.
- Mechanically rugged.
- Standard : gray face, white segment.
- RoHS compliant.

### Description

The Hyper Red source color devices are made with AlGaInP on GaAs substrate Light Emitting Diode.

### Package Dimensions & Internal Circuit Diagram

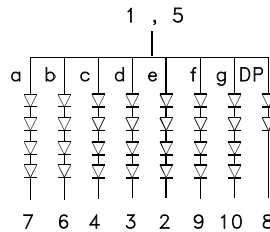
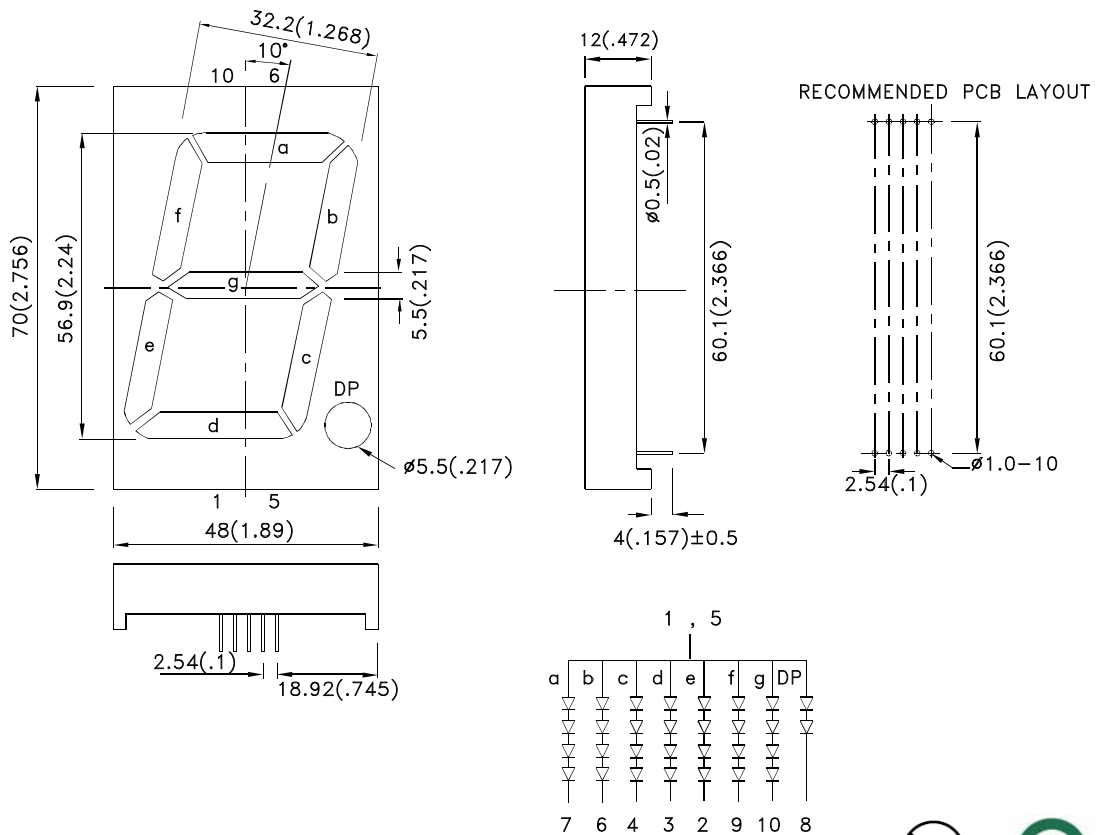

#### Notes:

1. All dimensions are in millimeters (inches), Tolerance is  $\pm 0.25(0.01)$  unless otherwise noted.
2. The specifications, characteristics and technical data described in the datasheet are subject to change without prior notice.



## Selection Guide

Part No.	Dice	Lens Type	Iv (ucd) [1] @ 10mA		Description
			Min.	Typ.	
SA23-11SURKWA	Hyper Red (AlGaInP)	White Diffused	88000	260000	Common Anode, Rt. Hand Decimal.

Note:

1. Luminous Intensity / Luminous Flux: +/-15%.

## Electrical / Optical Characteristics at TA=25°C

Symbol	Parameter	Device	Typ.	Max.	Units	Test Conditions
$\lambda_{peak}$	Peak Wavelength	Hyper Red	650		nm	IF=20mA
$\lambda_D$ [1]	Dominant Wavelength	Hyper Red	630		nm	IF=20mA
$\Delta\lambda_{1/2}$	Spectral Line Half-width	Hyper Red	28		nm	IF=20mA
C	Capacitance	Hyper Red	35		pF	VF=0V;f=1MHz
VF [2]	Forward Voltage Per Segment Or (DP)	Hyper Red	7.8 (3.9)	10.0 (5.0)	V	IF=20mA
IR	Reverse Current Per Segment Or (DP)	Hyper Red		10 (10)	uA	VR=5V (VR=5V)

Notes:

1. Wavelength: +/-1nm.
2. Forward Voltage: +/-0.1V.

## Absolute Maximum Ratings at TA=25°C

Parameter	Hyper Red	Units
Power dissipation Per Segment Or (DP)	300 (150)	mW
DC Forward Current Per Segment Or (DP)	30 (30)	mA
Peak Forward Current [1] Per Segment Or (DP)	185 (185)	mA
Reverse Voltage Per Segment Or (DP)	5 (5)	V
Operating / Storage Temperature	-40°C To +85°C	
Lead Solder Temperature[2]	260°C For 3-5 Seconds	

Notes:

1. 1/10 Duty Cycle, 0.1ms Pulse Width.
2. 2mm below package base.

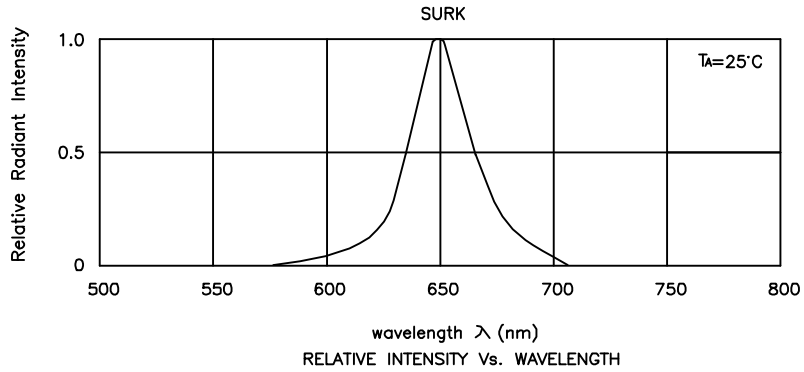

## SA23-11SURKWA Hyper Red

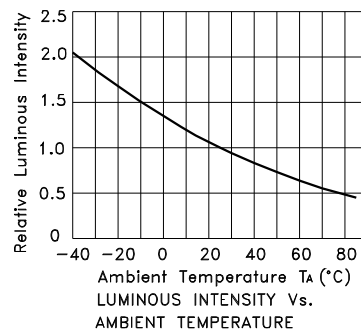
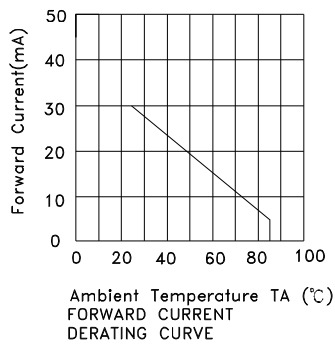
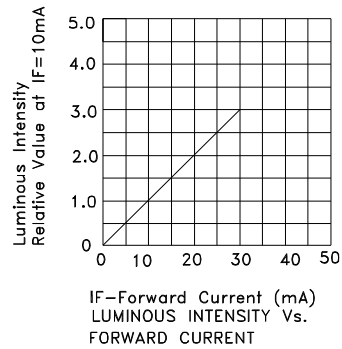
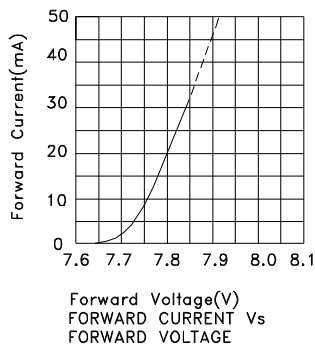

## Hyper Red

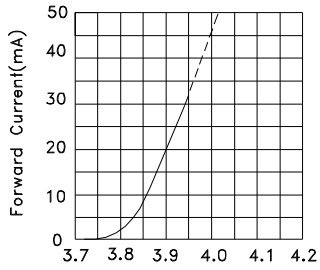

Forward Voltage(V)  
FORWARD CURRENT Vs  
FORWARD VOLTAGE

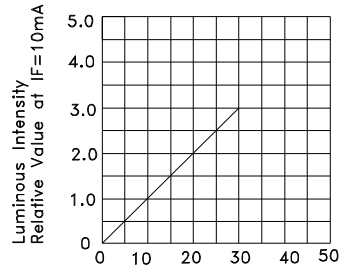

IF-Forward Current (mA)  
LUMINOUS INTENSITY Vs.  
FORWARD CURRENT

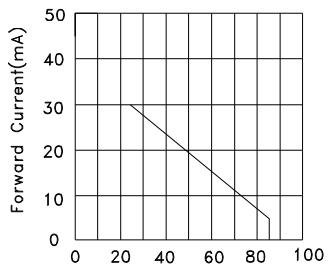

Ambient Temperature TA (°C)  
FORWARD CURRENT  
DERATING CURVE

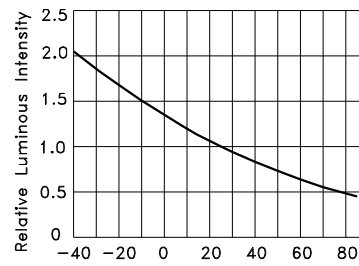

Ambient Temperature TA (°C)  
LUMINOUS INTENSITY Vs.  
AMBIENT TEMPERATURE

## PACKING & LABEL SPECIFICATIONS

## SA23-11SURKWA

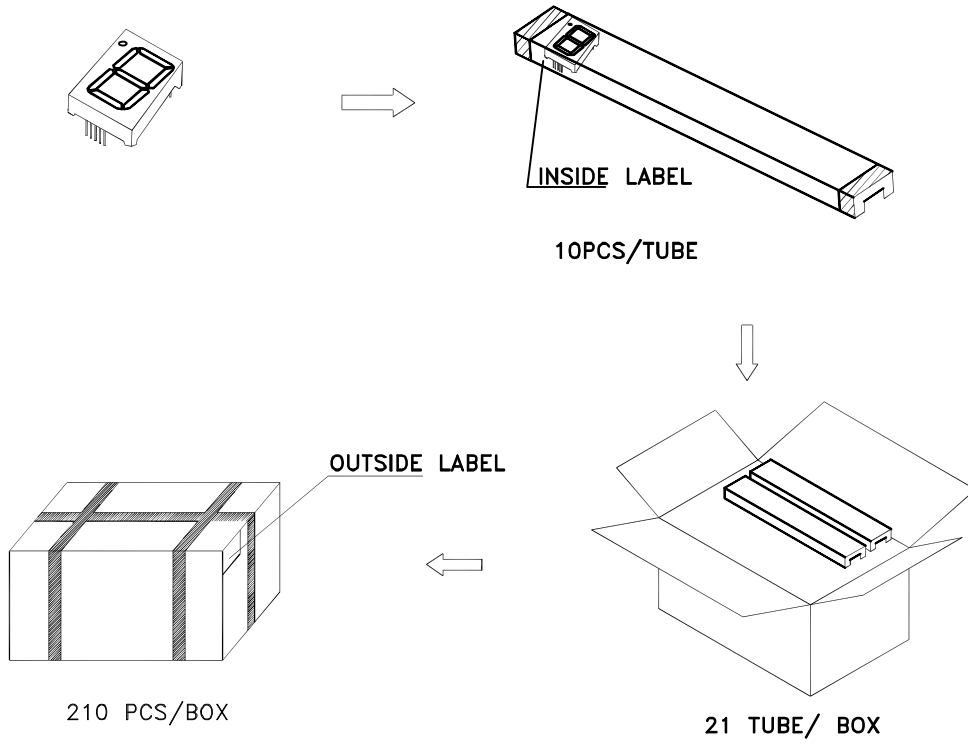

Inside Label on Ic-Tube

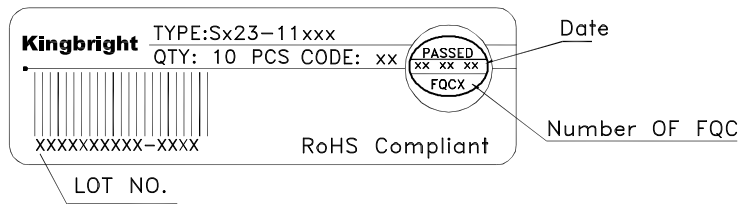

Outside Label on Box

